



PIETRA CORNER SOFA

Norde

TECHNICAL SPECIFICATIONS

Designed by
Norde Design Studio

INTERIOR STRUCTURE FRAME BEECH AND ELASTIC COLUMN

SEAT CUSHION HR FOAM

BACK HR FOAM

UPHOLSTERY TIGHT

MAINTENANCE ALL DECORATIVE CUSHIONS ARE GOOSE DOWN AND SILICON MIX, QUANTITY AND DIMENSIONS ARE AS PER TECHNICAL DRAWINGS. STANDART WITH 4 CUSHIONS 45*45, 3 CUSHIONS 35*50

We recommend shaking and fluffing-up the cushions regularly to maintain the shape. This should be done after removing the cushions from the structure for improved air circulation. For maintenance of fabric and leather, please contact your retailer.

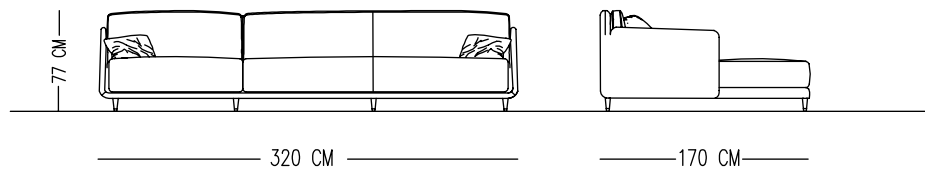

STANDARDS

CORNER SOFA - 320 CM

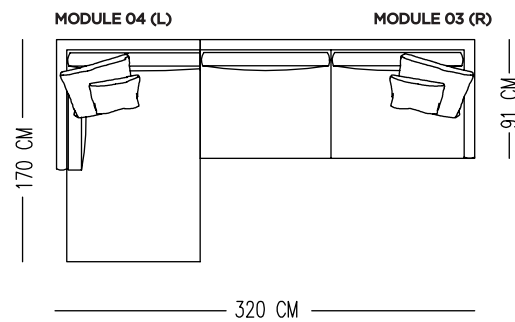

MODULES

MODULE 01 (L-R)

MODULE 02 (L-R)

MODULE 03 (L-R)

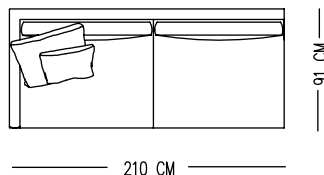
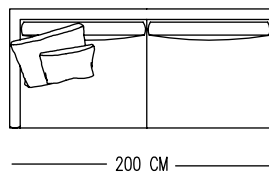
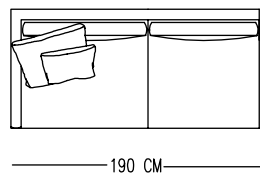

MODULE 04 (L-R)

CUSHION 01

CUSHION 02

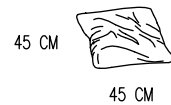
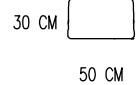
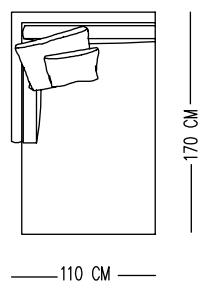

Catalog product-fabric

N-B32/Linen
213-13

Catalog product-Legs

Wood black and brass
old detail

Alternative fabric
Linen and Boucle